



MODEL:
GRAND-BDE Series

**Storage Server with Intel® Xeon® D Processor, Up to 128 GB
DDR4 RAM, Quad GbE Port, PCIe 3.0 x8/x4 Slots,
2U Rack Mount Chassis, 450 W Redundant PSU, RoHS**

User Manual

Revision

Date	Version	Changes
April 13, 2018	1.00	Initial release

Copyright

COPYRIGHT NOTICE

The information in this document is subject to change without prior notice in order to improve reliability, design and function and does not represent a commitment on the part of the manufacturer.

In no event will the manufacturer be liable for direct, indirect, special, incidental, or consequential damages arising out of the use or inability to use the product or documentation, even if advised of the possibility of such damages.

This document contains proprietary information protected by copyright. All rights are reserved. No part of this manual may be reproduced by any mechanical, electronic, or other means in any form without prior written permission of the manufacturer.

TRADEMARKS

All registered trademarks and product names mentioned herein are used for identification purposes only and may be trademarks and/or registered trademarks of their respective owners.

Manual Conventions



WARNING

Warnings appear where overlooked details may cause damage to the equipment or result in personal injury. Warnings should be taken seriously.



CAUTION

Cautionary messages should be heeded to help reduce the chance of losing data or damaging the product.



NOTE

These messages inform the reader of essential but non-critical information. These messages should be read carefully as any directions or instructions contained therein can help avoid making mistakes.



HOT SURFACE

This symbol indicates a hot surface that should not be touched without taking care.

Table of Contents

1 INTRODUCTION.....	1
1.1 OVERVIEW.....	2
1.2 FEATURES.....	2
1.3 FRONT PANEL.....	3
1.3.1 LED Indicator Specifications.....	4
1.4 REAR PANEL.....	6
1.5 SPECIFICATIONS	7
2 UNPACKING	9
2.2 PACKING LIST.....	10
2.3 OPTIONAL ITEMS.....	11
3 INSTALLATION	13
3.1 ANTI-STATIC PRECAUTIONS.....	14
3.2 INSTALLATION PRECAUTIONS.....	14
3.2.1 High Surface Temperature.....	15
3.3 MEMORY MODULE INSTALLATION	16
3.4 EXPANSION CARD INSTALLATION.....	18
3.5 HARD DRIVE INSTALLATION.....	21
3.5.1 Hard Drive Bay Numbering.....	22
3.5.2 Installing Hard Drive.....	24
3.6 POWER-ON PROCEDURE.....	26
3.6.1 Installation Checklist.....	26
3.6.2 Power-on Procedure	26
4 MAINTENANCE.....	28
4.1 COMPONENT REPLACEMENT PROCEDURE	29
4.2 POWER SUPPLY UNIT REPLACEMENT	30
5 INTERFACE CONNECTORS.....	32
5.1 PERIPHERAL INTERFACE CONNECTORS.....	33
5.1.1 CPLD Connector	34

5.1.2 10Gbps Host Connector (PCIe Slot 5).....	34
5.1.3 PCIe Power Connector (CON2).....	35
5.1.4 LPC Connector (CN8).....	36
5.1.5 COM Connector (CN2, CN17, CON7).....	36
5.1.6 Thermistor (RT7, RT9, RT10, RT11).....	36
5.2 EXTERNAL INTERFACE PANEL CONNECTORS.....	37
5.2.1 Ethernet and USB 3.0 Combo Connectors.....	37
5.2.2 Console Port.....	38
5.2.3 EC GPIO.....	38
5.2.4 SAS Connector.....	38
A REGULATORY COMPLIANCE.....	40
B SAFETY PRECAUTIONS.....	45
B.1 SAFETY PRECAUTIONS.....	46
B.1.1 General Safety Precautions.....	46
B.1.2 Anti-static Precautions.....	47
B.1.3 Product Disposal.....	48
B.2 MAINTENANCE AND CLEANING PRECAUTIONS.....	48
B.2.1 Maintenance and Cleaning.....	48
B.2.2 Cleaning Tools.....	49
C HAZARDOUS MATERIALS DISCLOSURE.....	50

List of Figures

Figure 1-1: GRAND-BDE Series Storage Server	2
Figure 3-1: Power Connection	27
Figure 3-2: Power Button	27
Figure 5-1: Jumper and Connector Locations	33

List of Tables

Table 1-1: Specifications	8
Table 2-1: Package List.....	10
Table 2-2: Optional Items	12
Table 5-1: CPLD Connector Pinouts.....	34
Table 5-2: 10Gbps Host Connector (PCIe Slot 5) Pinouts	35
Table 5-3: PCIe Power Connector (CON2) Pinouts	35
Table 5-4: LPC Connector (CN8) Pinouts.....	36
Table 5-5: COM Connector (CN2, CN17, CON7) Pinouts	36
Table 5-6: Ethernet Connector Pinouts	37
Table 5-7: USB 3.0 Connector Pinouts.....	37
Table 5-8: Console Port Pinouts	38
Table 5-9: EC GPIO Pinouts.....	38
Table 5-10: SAS Connector Pinouts	39

Chapter

1

Introduction

1.1 Overview



Figure 1-1: GRAND-BDE Series Storage Server

Powered by an advanced 14nm Intel® Xeon® D 64-bit SoC processor with an integrated PCH, and up to 128 GB DDR4 ECC RDIMM RAM, the GRAND-BDE series storage server delivers outstanding performance for data transmission and applications.

The GRAND-BDE supports SAS 12Gb/s 2.5" drives, allowing for SAS 12Gb/s and SATA 6Gb/s hard drives and SSDs. Businesses can create the most cost-effective storage by implementing suitable drives based on their needs.

1.2 Features

The GRAND-BDE series has the following features

- Dual Intel® Xeon® D processor (with 4-core, 6-core and 8-core configurations)
- Supports four DDR4 RAM modules for UDIMM and ECC RDIMM (up to 64GB UDIMM RAM, up to 128GB RDIMM RAM)
- Supports 12Gb/s SAS hard drives and SSDs for fast data transfer and highly-reliable storage.
- Four high-speed PCIe Gen.3 and one PCIe Gen.2; supports 10GbE/ 40GbE adapters and PCIe NVMe SSD
- Four Gigabit ports

GRAND-BDE Series

1.3 Front Panel

GRAND-BDE-18B:



GRAND-BDE-30B:



1	Power button
2	<p>LED Indicator:</p> <div style="display: flex; align-items: center;"> <div style="border: 1px solid gray; border-radius: 10px; padding: 5px; margin-right: 10px; text-align: center;"> <p>10</p> <p>i</p> <p>LAN</p> <p>Storage expansion port status</p> </div> <div> <p>10 GbE</p> <p>System status</p> <p>LAN</p> <p>Storage expansion port status</p> </div> </div>

1.3.1 LED Indicator Specifications

The LED indicators of the GRAND-BDE indicate the system status and information. The following table lists the LED indicator behavior. Note that the following information is applicable only when users have properly installed the hard drive, and connected the system to the power supply.

LED	Color	LED Status	Description
10 GbE	Green	Green	The 10GbE network expansion card is installed.
		Off	No 10GbE network expansion card is installed.
System Status	Red/Green	Red	<ol style="list-style-type: none"> 1. The hard drive is invalid. 2. The disk volume has reached its full capacity. 3. The disk volume is going to be full. 4. The system fan is out of function. 5. An error occurs when accessing (read/write) the disk data. 6. A bad sector is detected on the hard drive.
		Green	The system is ready.
		Deep flashes of orange	The system is in sleep mode.
		Off	All the hard drives are in standby mode.
LAN	Orange	Orange	The disk data is being accessed from the network and a read/write error occurs during the process.
		Flashes orange	The system is connected to the network.
Storage Expansion Port Status	Orange	Off	No expansion enclosures are detected.
		Orange	Expansion enclosures are detected.
HDD	Red/ Green	Red	A hard drive read/write error occurs.
		Flashes green	The disk data is being accessed.
		Green	The hard drive can be accessed.

GRAND-BDE Series

LED indicator locations:

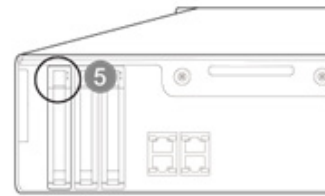
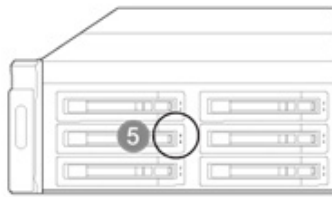
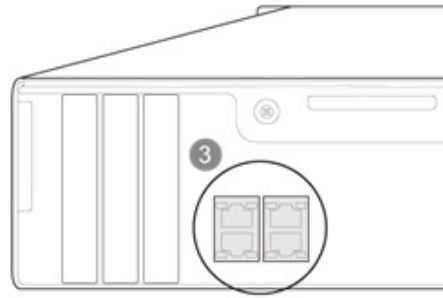
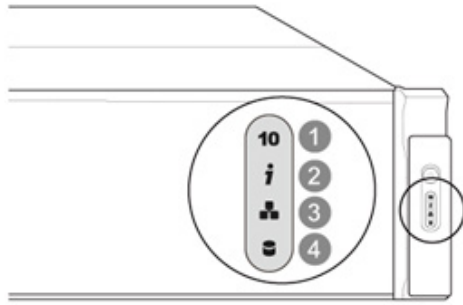

1.4 Rear Panel

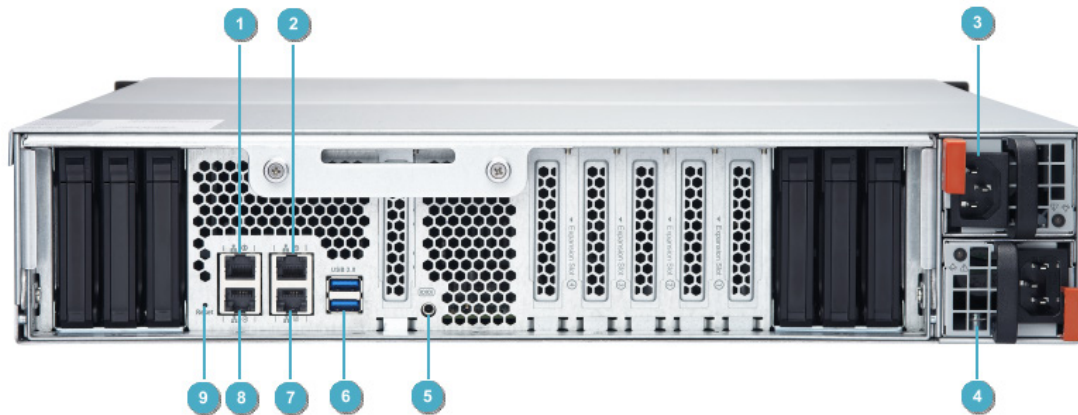

1	Gigabit Ethernet port 3	6	USB 3.0 ports
2	Gigabit Ethernet port 1	7	Gigabit Ethernet port 2
3	Power supply unit 1	8	Gigabit Ethernet port 4
4	Power supply unit 2	9	EC GPIO
5	Console port		

GRAND-BDE Series

1.5 Specifications

The specifications for the GRAND-BDE series are listed below.

	GRAND-BDE-18B	GRAND-BDE-30B
CPU	Intel® Xeon® D series processor	
Memory	Total memory slots: 4 x DDR4 RDIMM/UDIMM	
	Max. memory: DDR4 128 GB (4 x 32 GB RDIMM)	
Drive Tray	Front: 12 x 2.5" / 3.5"	Front: 24 x 2.5"
	Rear: 6 x 2.5" SSD drive bay	Rear: 6 x 2.5" SSD drive bay
Hard Drive	Front: SAS 12Gb/s, SAS 6Gb/s, SATA 6Gb/s and SSD Rear: SATA 6Gb/s and SSD	
USB	2 x USB 3.0 port (rear)	
LAN	4 x 10/100/1000 Mbps LAN port	
PCIe Slot	Slot 1: PCIe 3.0 x8 Slot 2: PCIe 2.0 x4 Slot 3: PCIe 3.0 x4 Slot 4: PCIe 3.0 x4 or PCIe 3.0 x8* Slot 5: PCIe 3.0 x4**	
	* Slot 4 provides the bandwidth of PCIe 3.0 x8 when Slot 3 is not in use. Slot 4 then provides the bandwidth of PCIe 3.0 x4 only when an expansion board is installed in Slot 3. ** Slot 5 is a reverse connector that supports a specific 10GbE LAN card (LAN-10G2F-PHY-CS4227).	
LEDs	10 GbE network, system status, network, drive LED	
Button	Power button	
Form Factor	2U, rack mount	
Dimensions (HxWxD)	88 mm x 442.5 mm x 530.5 mm	88 mm x 439 mm x 484.5 mm

	3.46" x 17.42" x 20.89"	3.47" x 17.28" x 19.07"
Power Consumption	In operation: 255.04 W	In operation: 229.53 W
Power Supply	Redundant power: input 90 to 264VAC; 2 x 450W	
Operating Temperature	0~40°C	
Relative Humidity	5 to 95% non-condensing, wet bulb: 27°C	
Fan	4 x 6-cm high-efficiency cooling fan	

Table 1-1: Specifications

Chapter

2

Unpacking

2.2 Packing List



NOTE:

If any of the components listed in the checklist below are missing, do not proceed with the installation. Contact the IEI reseller or vendor the GRAND-BDE was purchased from or contact an IEI sales representative directly by sending an email to sales@ieiworld.com.

The GRAND-BDE is shipped with the following components:





Quantity	Item	Image
4	Ethernet cable	
2	Power cord	
1	Screw pack for 2.5" HDD installation	
1	Screw pack for 3.5" HDD installation (GRAND-BDE-18B only)	

Table 2-1: Package List

GRAND-BDE Series

2.3 Optional Items

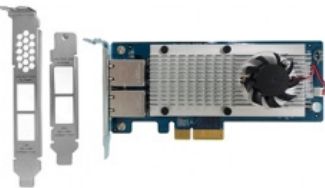
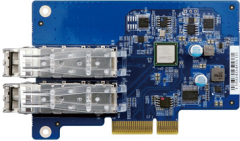
The following are optional components which may be separately purchased:

Item and Part Number	Image
Dual-port 40GbE QSFP+ network expansion card (P/N: LAN-40G2SF-MLX)	
Dual-port 10GbE SFP+ network expansion card (P/N: LAN-10G2SF-MLX)	
Dual-port 10GBASE-T network expansion card (P/N: LAN-10G2T-X550)	
Dual-port 10GbE LAN card (P/N: LAN-10G2F-PHY-CS4227)	
USB 3.1 Gen 2 10Gbps Type-A dual-port PCIe card (P/N: USB-U31A2P01)	
Dual-port storage expansion, SAS 12Gbps (P/N: SAS-12G2E)	



Item and Part Number	Image
MiniSAS cable (SFF-8644 to SFF-8644), 1.0 m (P/N: CAB-SAS10M-8644)	
MiniSAS cable (SFF-8644 to SFF-8644), 0.5m (P/N: CAB-SAS05M-8644)	
Rail kit for rackmount, max. load 57 kg (P/N: RAIL-A03-57)	

Table 2-2: Optional Items

Chapter

3

Installation

3.1 Anti-static Precautions

**WARNING:**

Failure to take ESD precautions during the maintenance of the GRAND-BDE may result in permanent damage to the GRAND-BDE and severe injury to the user.

Electrostatic discharge (ESD) can cause serious damage to electronic components, including the WAFER series motherboard and the power module. (Dry climates are especially susceptible to ESD.) It is therefore critical that whenever the GRAND-BDE is opened and any electrical component handled, the following anti-static precautions are strictly adhered to.

- **Wear an anti-static wristband:** Wearing a simple anti-static wristband can help to prevent ESD from damaging the board.
- **Self-grounding:** Before handling the board, touch any grounded conducting material. During the time the board is handled, frequently touch any conducting materials that are connected to the ground.
- **Use an anti-static pad:** When configuring the GRAND-BDE, place it on an anti-static pad. This reduces the possibility of ESD damaging the GRAND-BDE.

3.2 Installation Precautions

During installation, be aware of the precautions below:

- **Read the user manual:** The user manual provides a complete description of the GRAND-BDE, installation instructions and configuration options.
- **DANGER! Disconnect Power:** Power to the GRAND-BDE must be disconnected during the installation process. Failing to disconnect the power may cause severe injury to the body and/or damage to the system.
- **Qualified Personnel:** The GRAND-BDE must be installed and operated only by trained and qualified personnel. Maintenance, upgrades, or repairs may

GRAND-BDE Series

only be carried out by qualified personnel who are familiar with the associated dangers.

- **Air Circulation:** Make sure there is sufficient air circulation when installing the GRAND-BDE. The GRAND-BDE's cooling vents must not be obstructed by any objects. Blocking the vents can cause overheating of the GRAND-BDE. Leave at least 5 cm of clearance around the GRAND-BDE to prevent overheating.
- **Grounding:** The GRAND-BDE should be properly grounded. The voltage feeds must not be overloaded. Adjust the cabling and provide external overcharge protection per the electrical values indicated on the label attached to the back of the GRAND-BDE.

3.2.1 High Surface Temperature



WARNING:

Some surfaces of the equipment may become hot during operation.

The surface temperature may be up to several tens of degrees hotter than the ambient temperature. Under these circumstances, the equipment needs to be protected against accidental contact.

The equipment is intended for installation in a RESTRICTED ACCESS LOCATION.

- Access can only be gained by SERVICE PERSONS or by USERS who have been instructed about the reasons for the restrictions applied to the location and about any precautions that shall be taken.
- Access is through the use of a TOOL or lock and key, or other means of security, and is controlled by the authority responsible for the location.

3.3 Memory Module Installation

The GRAND-BDE has four memory slots and supports DDR4 RDIMMs and UDIMMs. To install a memory module, follow the steps below:

- Step 1:** Turn off the GRAND-BDE. Disconnect the power adaptor, network cable(s), and any other connectors or cables from the GRAND-BDE.
- Step 2:** Put on an antistatic wrist strap to prevent electrostatic discharge. The crocodile clip should be connected to the ground.
- Step 3:** Loosen the 2 screws on the rear of the GRAND-BDE as shown below.

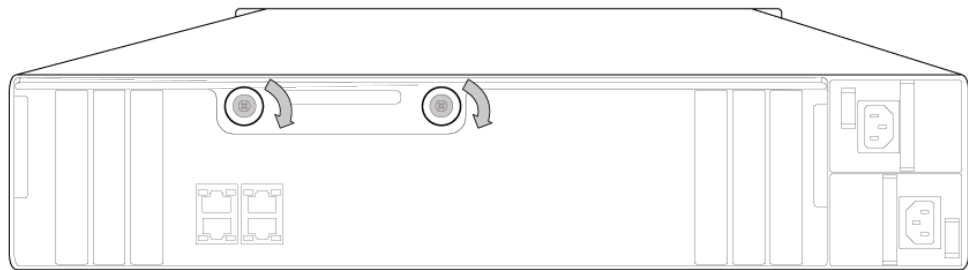

- Step 4:** Pull the handle outwards to remove the motherboard drawer.

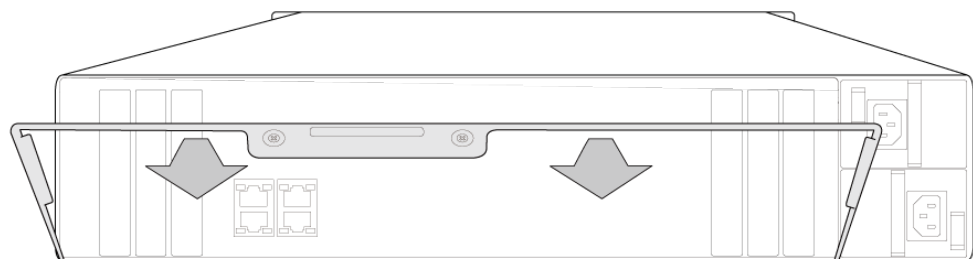

- Step 5:** Release the ejector clips gently by pulling them out of the sides of the RAM slot.
- Step 6:** Grip the new RAM on the edges to avoid touching contacts or circuitry on the module.

GRAND-BDE Series

Step 7: Line up the notch on the RAM to the break in the slot. Ensure that first RAM module is inserted into slot 1 (see below for slot positioning).

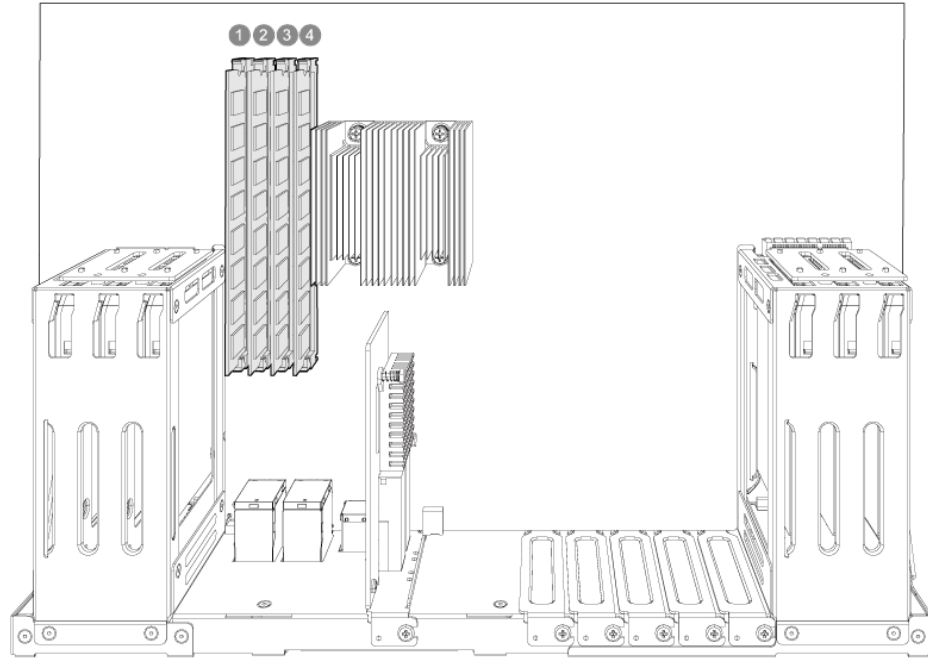

Step 8: Set the stick into the slot and apply equal pressure onto both ends of the stick until the clamps on the side click and fully lock the RAM in.

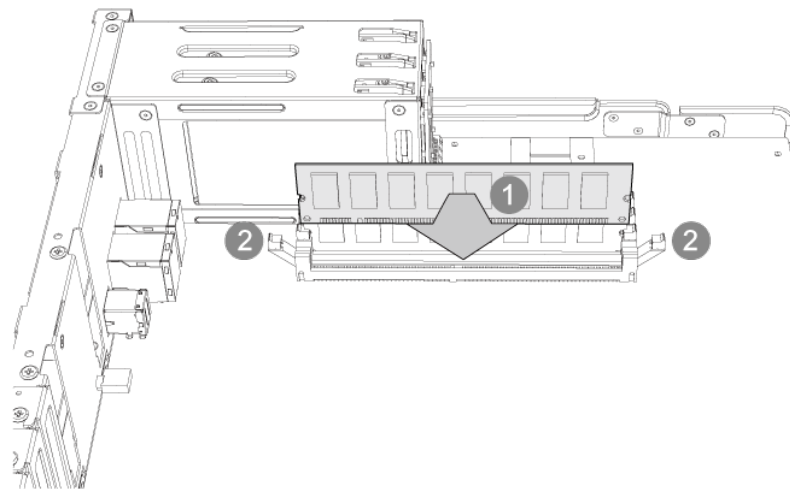

Step 9: Slide the motherboard drawer back into the GRAND-BDE and pull the handle up to close enclosure and insert screws on the handle.

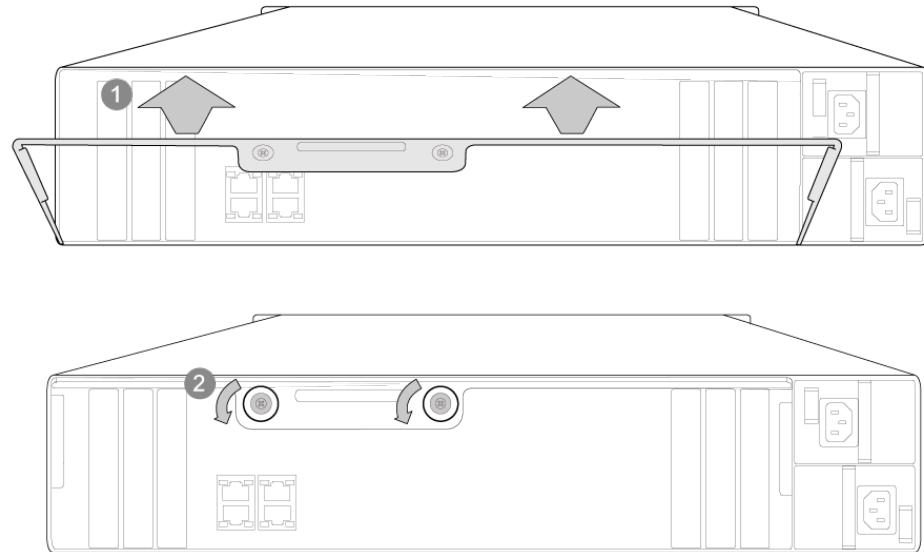

Step 10: Reconnect all cables back into the GRAND-BDE.

3.4 Expansion Card Installation



WARNING!

The following instructions should only be performed by an authorized and trained technician.

Strictly adhere to the instructions to install a network expansion card on the system. Failure to do so could result in injury to human body or death.

The PCIe Slot 5 is a reverse connector that supports a specific 10GbE LAN card (LAN-10G2F-PHY-CS4227).

The GRAND-BDE provides five low-profile PCIe expansion slots so that users can add functionality to their system.

GRAND-BDE Series

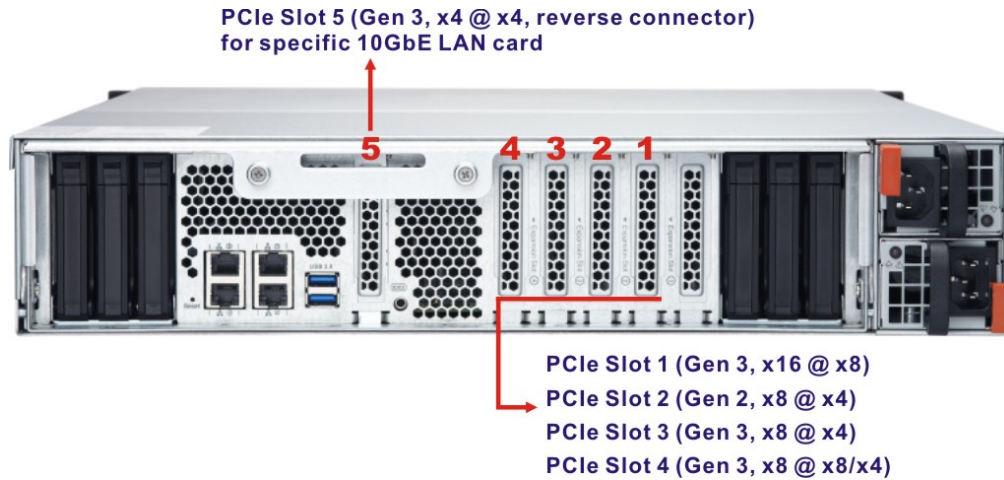

To install expansion card, follow the steps below.

- Step 1:** Turn off the GRAND-BDE. Disconnect the power adaptor, network cable(s), and any other connectors or cables from the GRAND-BDE.
- Step 2:** Before installing the network expansion card, put on an antistatic wrist strap to prevent electrostatic discharge. The crocodile clip should be connected to the ground.
- Step 3:** Loosen the 2 screws on the rear of the GRAND-BDE as shown below.

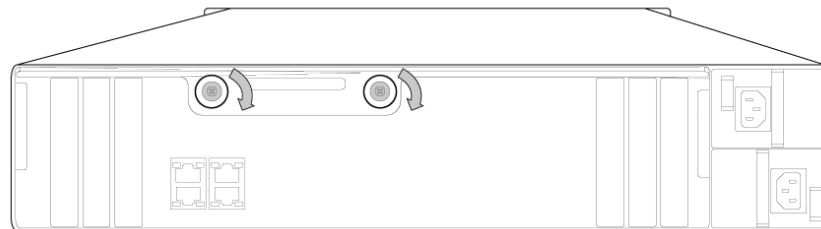

- Step 4:** Pull the handle outwards to remove the motherboard drawer.

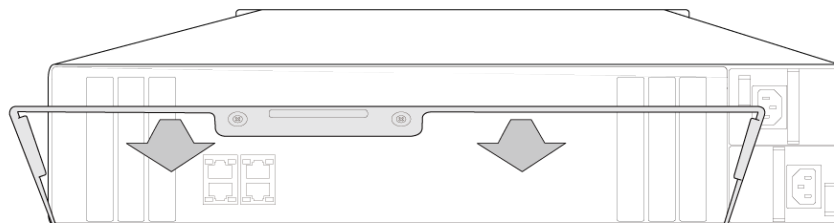

Step 5: Remove screw from the expansion slot cover and detach cover.

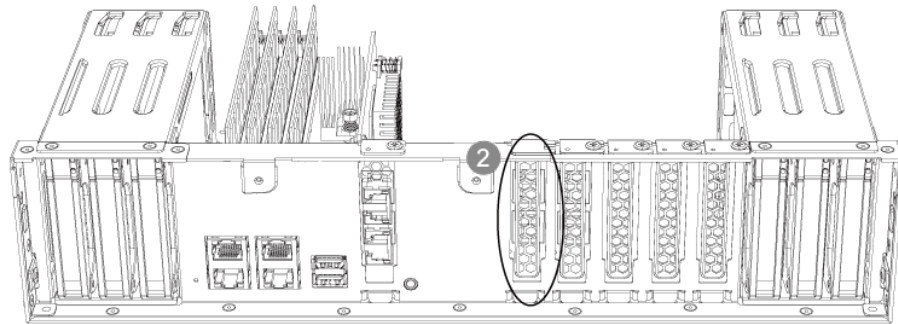
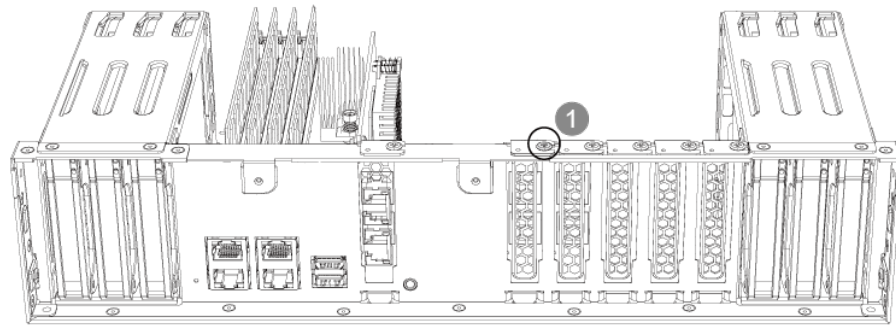

Step 6: Line up the notch on the expansion card to the break in the PCIe slot. Fully insert the expansion card to the expansion slot. Fasten screw to lock in card.

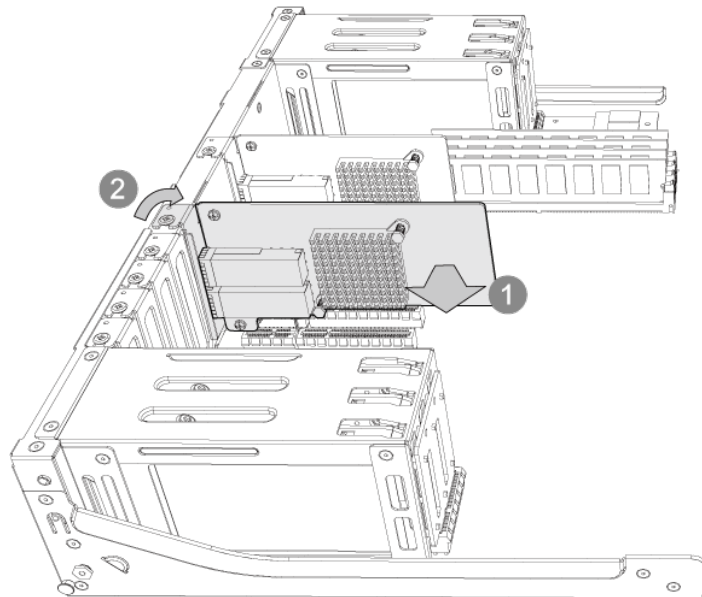

GRAND-BDE Series

Step 7: Slide the motherboard drawer back into the GRAND-BDE and pull the handle up to close enclosure and insert screws on the handle.

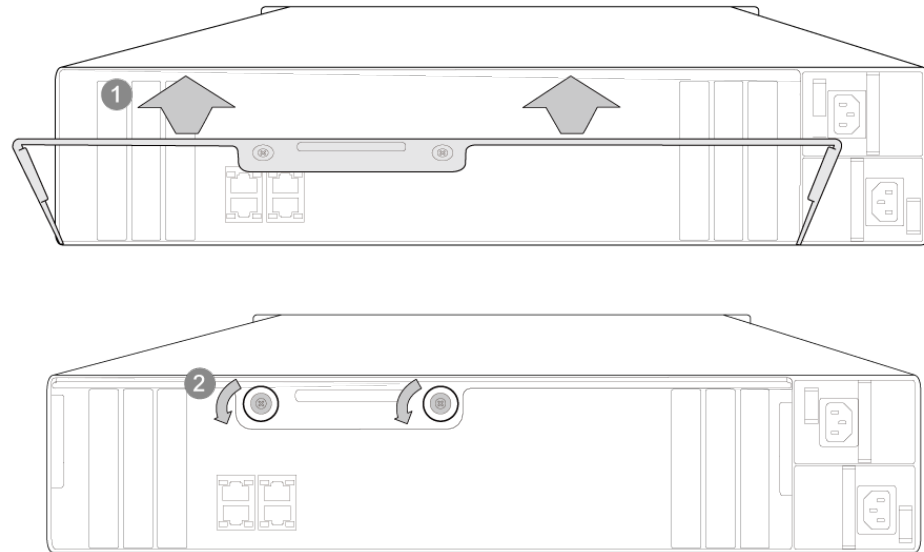

Step 8: Reconnect all cables back into the GRAND-BDE.

3.5 Hard Drive Installation

The GRAND-BDE series is compatible with 2.5-inch/3.5-inch SAS and SATA hard drives.



NOTE:

Before installing hard drives, ensure the disk drives (HDDs/SSDs) that you use are compatible with the GRAND-BDE.

3.5.1 Hard Drive Bay Numbering

GRAND-BDE-18B (front) bay numbering:

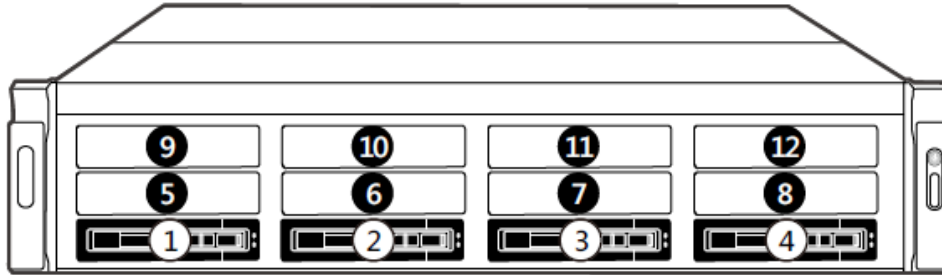

GRAND-BDE-18B (rear) bay numbering:

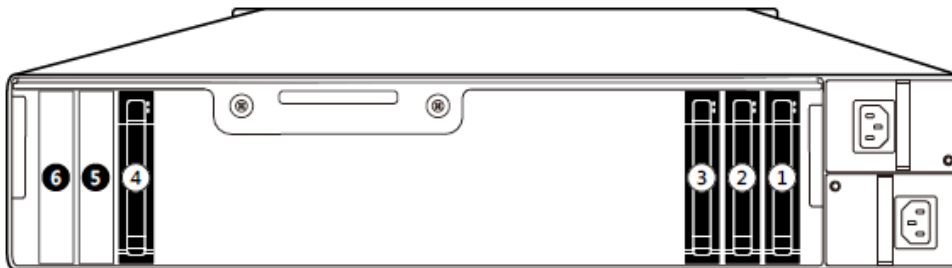

	GRAND-BDE-18B	
	Front	Rear
Supports 3.5-inch SAS/SATA Hard Drives	Yes	No
Supports 2.5-inch SAS/SATA Hard Drives	Yes	No
Supports 2.5-inch SSD	Yes	Yes

GRAND-BDE Series

GRAND-BDE-30B (front) bay numbering:

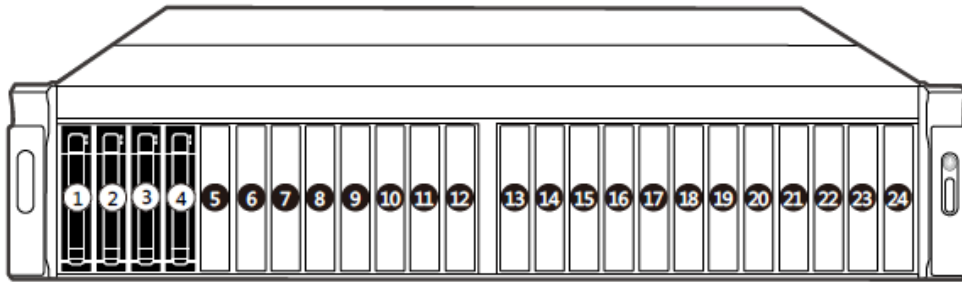

GRAND-BDE-30B (rear) bay numbering:

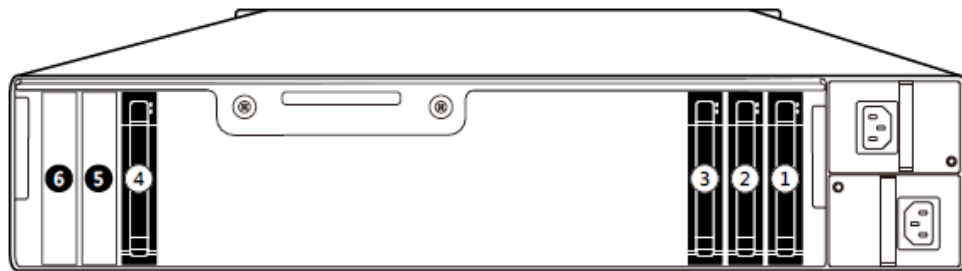

	GRAND-BDE-30B	
	Front	Rear
Supports 3.5-inch SAS/SATA Hard Drives	No	No
Supports 2.5-inch SAS/SATA Hard Drives	Yes	No
Supports 2.5-inch SSD	Yes	Yes

3.5.2 Installing Hard Drive

To install hard drives in GRAND-BDE series, follow the steps below:

Step 1: Unlock drive tray and remove from enclosure.

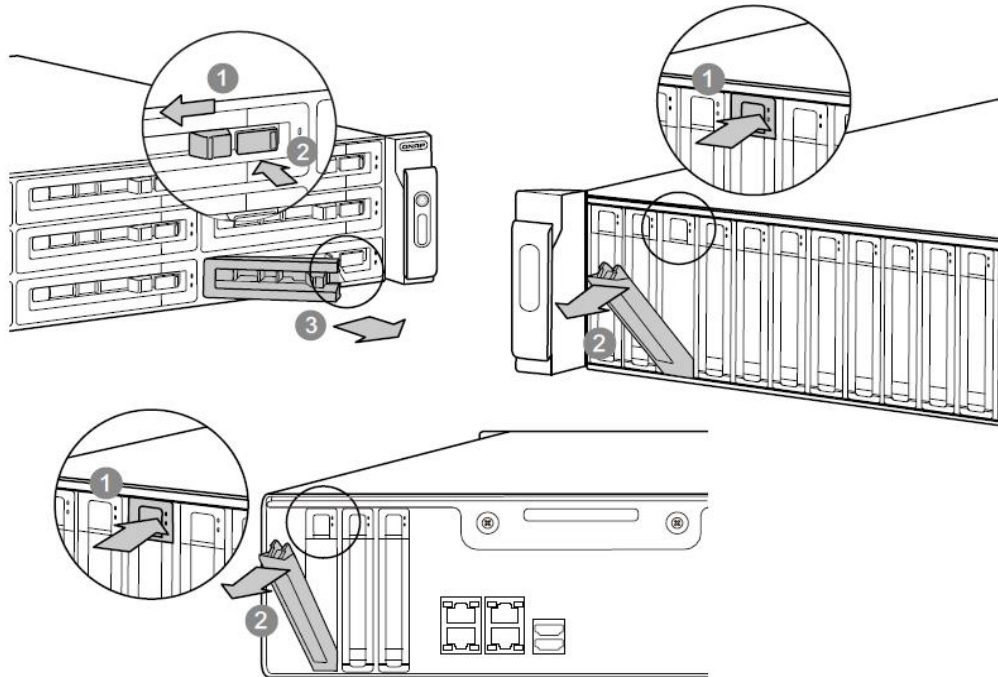

Step 2: Install a 3.5" or 2.5" disk drive to the tray.

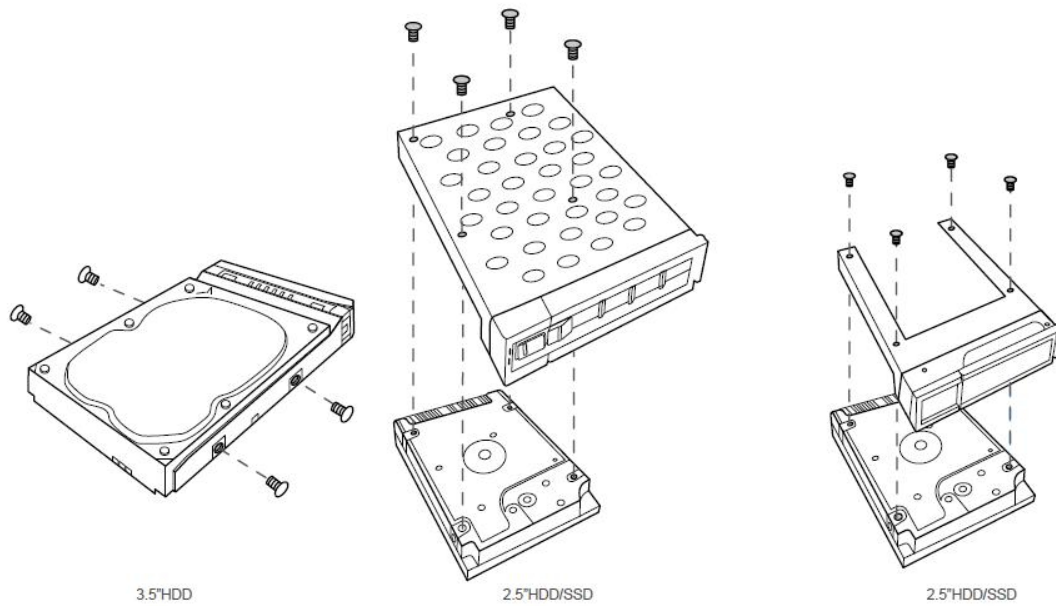

GRAND-BDE Series

Step 3: Insert the drive tray into the GRAND-BDE series, close and lock the latch. The rear panel of the GRAND-BDE has 4 drive slots for installing 2.5" SATA SSD. To install the hard drive into the system, please follow the steps below.

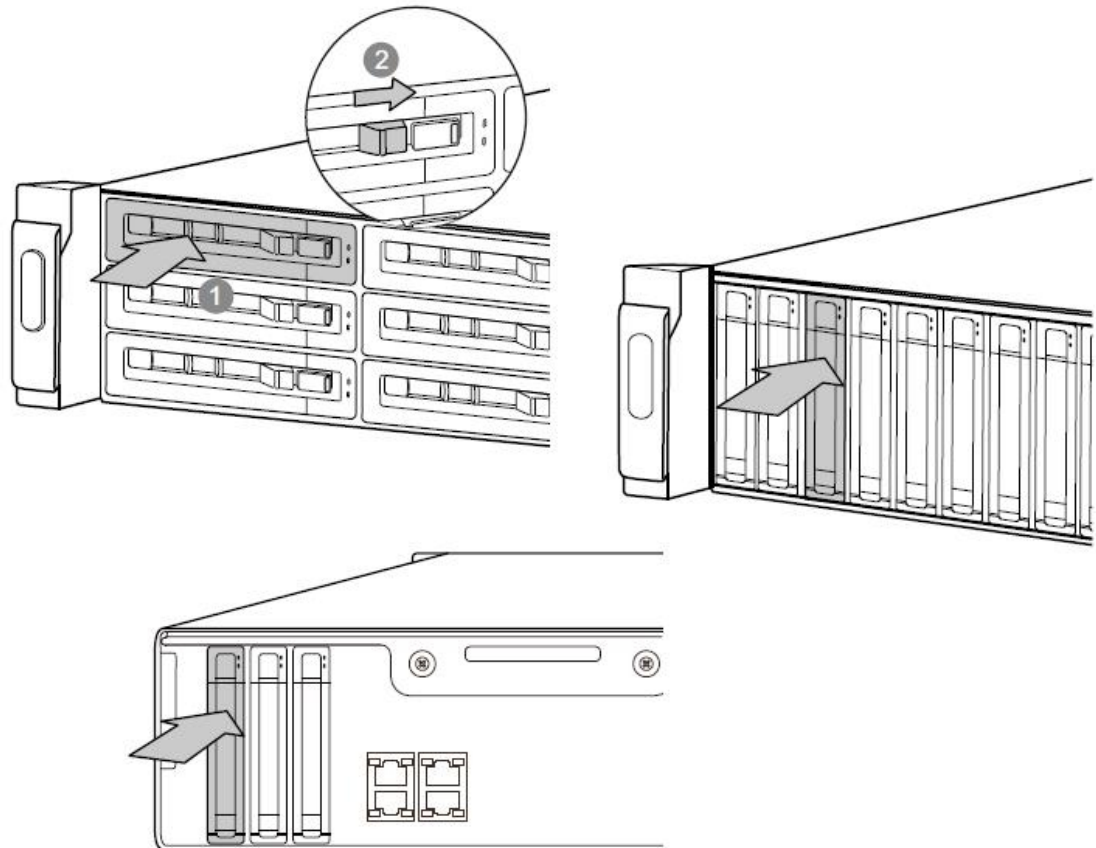

WARNING:

Users are strongly recommended to turn OFF the GRAND-BDE before replacing the hard drive to reduce the risk of electric shock.

**CAUTION:**

IEI disclaims any responsibility for product damage/malfunction or data loss/recovery due to misuse or improper installation of hard disks in any occasions for any reasons.

3.6 Power-On Procedure

3.6.1 Installation Checklist

**WARNING:**

Make sure a power supply with the correct input voltage is being fed into the system. Incorrect voltages applied to the system may cause damage to the internal electronic components and may also cause injury to the user.

To power on the GRAND-BDE, please make sure of the following:

- The HDD/SSD is installed
- The LAN cable is connected
- The power cables are plugged in
- The system is securely mounted

3.6.2 Power-on Procedure

To power-on the GRAND-BDE please follow the steps below:

Step 1: Connect the power source to the power input jacks.

GRAND-BDE Series

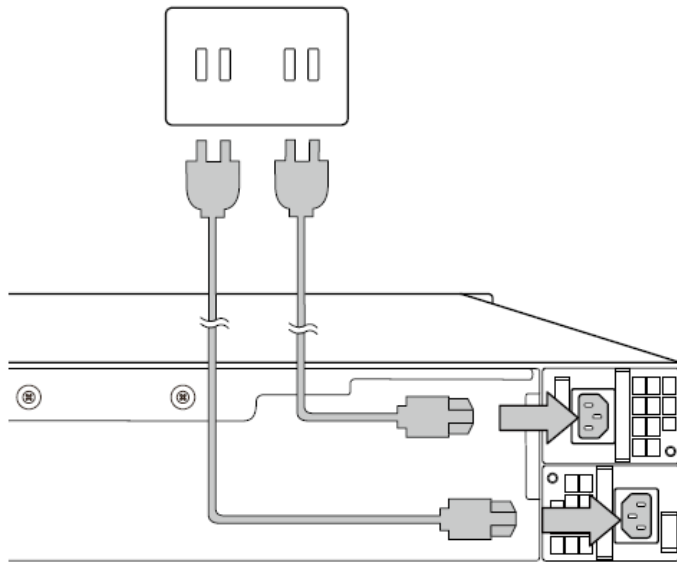

Figure 3-1: Power Connection

Step 2: Push the power button (**Figure 3-2**).

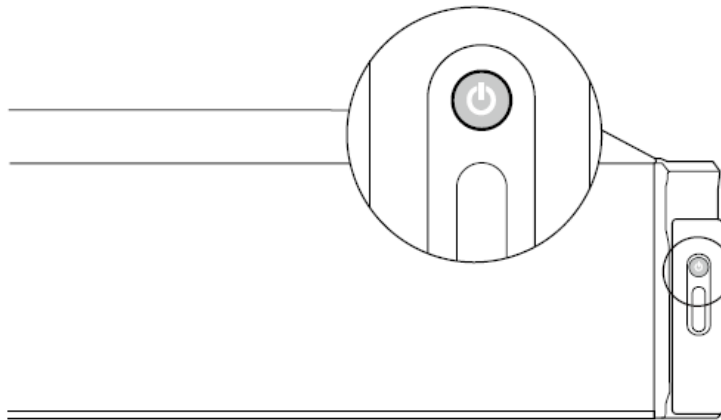

Figure 3-2: Power Button

Step 3: To turn off the GRAND-BDE, press the power button for 1.5 seconds.

To force turn off, press the power button for 5 seconds.

Chapter

4

Maintenance

GRAND-BDE Series



WARNING:

The following instructions should only be performed by an authorized and trained technician.

Before starting, please ensure that you turn off the GRAND-BDE, disconnect the power adaptor, network cable(s), and also remove any other device/cable that is attached to the server.

Take Anti-Static precautions whenever maintenance is being carried out on the system components. Failure to take anti-static precautions can cause permanent system damage. For more details on anti-static precautions, please refer to **Section 3.1**.

4.1 Component Replacement Procedure



WARNING!

Users are not advised to attempt to repair or replace any internal or external components of the GRAND-BDE storage server other than those listed below. If any other components fail or need replacement, contact the IEI reseller or vendor you purchased the GRAND-BDE from or contact an IEI sales representative directly. To contact an IEI sales representative, please send an email to sales@ieiworld.com.

The industrial server components listed below can all be replaced if they fail:

- SO-DIMM module (see **Section 3.3**)
- Expansion card (see **Section 3.4**)
- Internal hard disk drive (see **Section 3.5**)
- Power supply unit

4.2 Power Supply Unit Replacement

To replace a failed power supply unit, please follow the steps below.

Step 1: Turn off the GRAND-BDE. Disconnect the power adaptor, network cable(s), and any other connectors or cables from the GRAND-BDE.

Step 2: Firmly press and hold the orange button on back of PSU towards the black handle. Pull out power supply by pulling black handle.

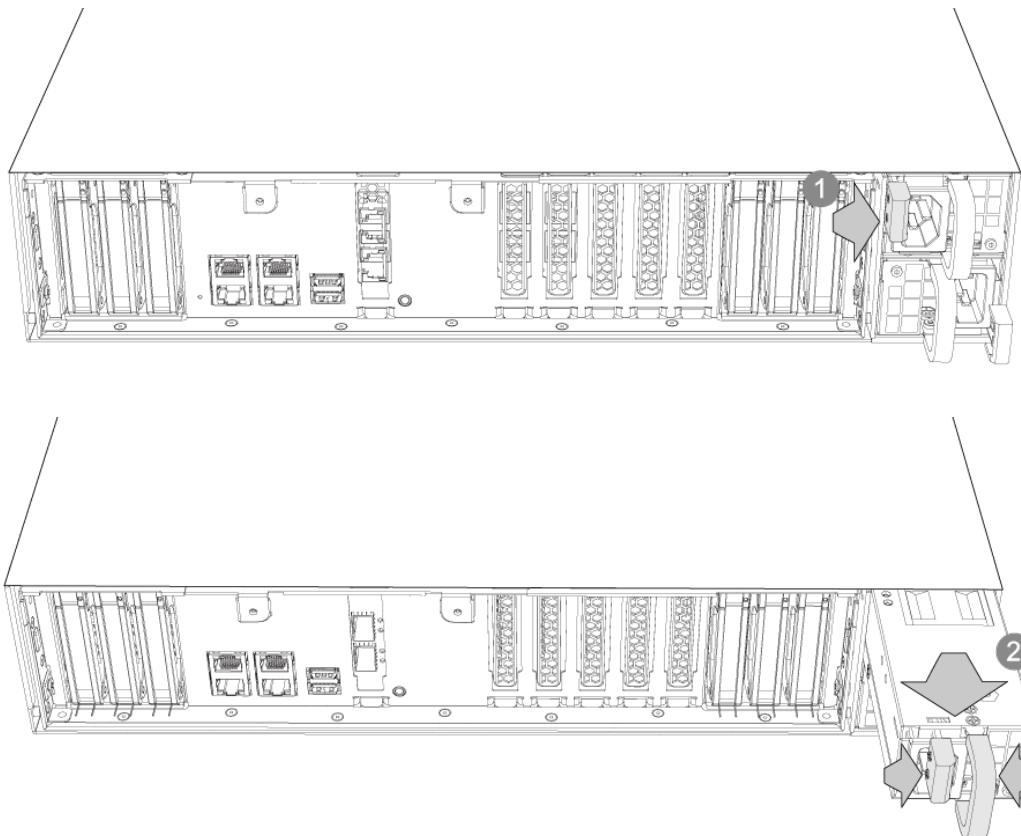

Step 3: Insert new power supply into the GRAND-BDE.

GRAND-BDE Series

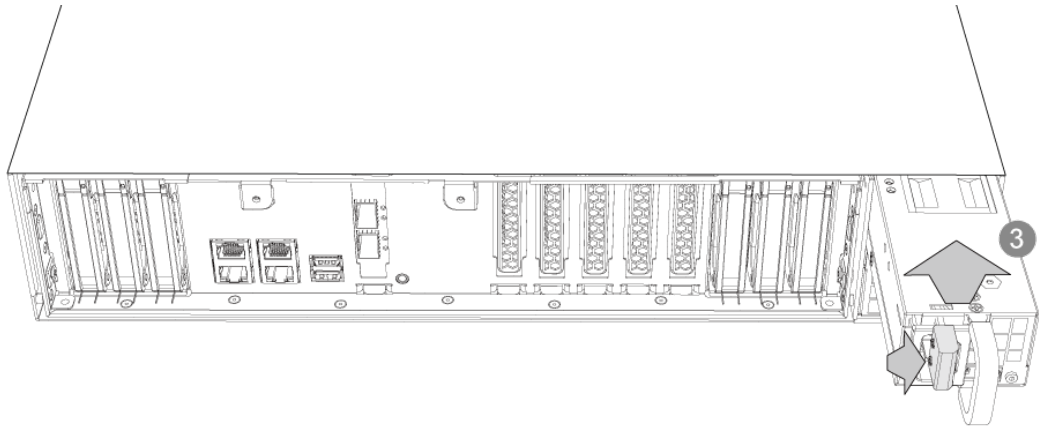

Step 4: Connect the power adaptor and cables to the GRAND-BDE.

Step 5: Power on the system.

Chapter

5

Interface Connectors

GRAND-BDE Series

5.1 Peripheral Interface Connectors

The GRAND-BDE system motherboard comes with a number of peripheral interface connectors. The connector locations are shown in **Figure 5-1**. The connector pinouts for these connectors are listed in the following sections.

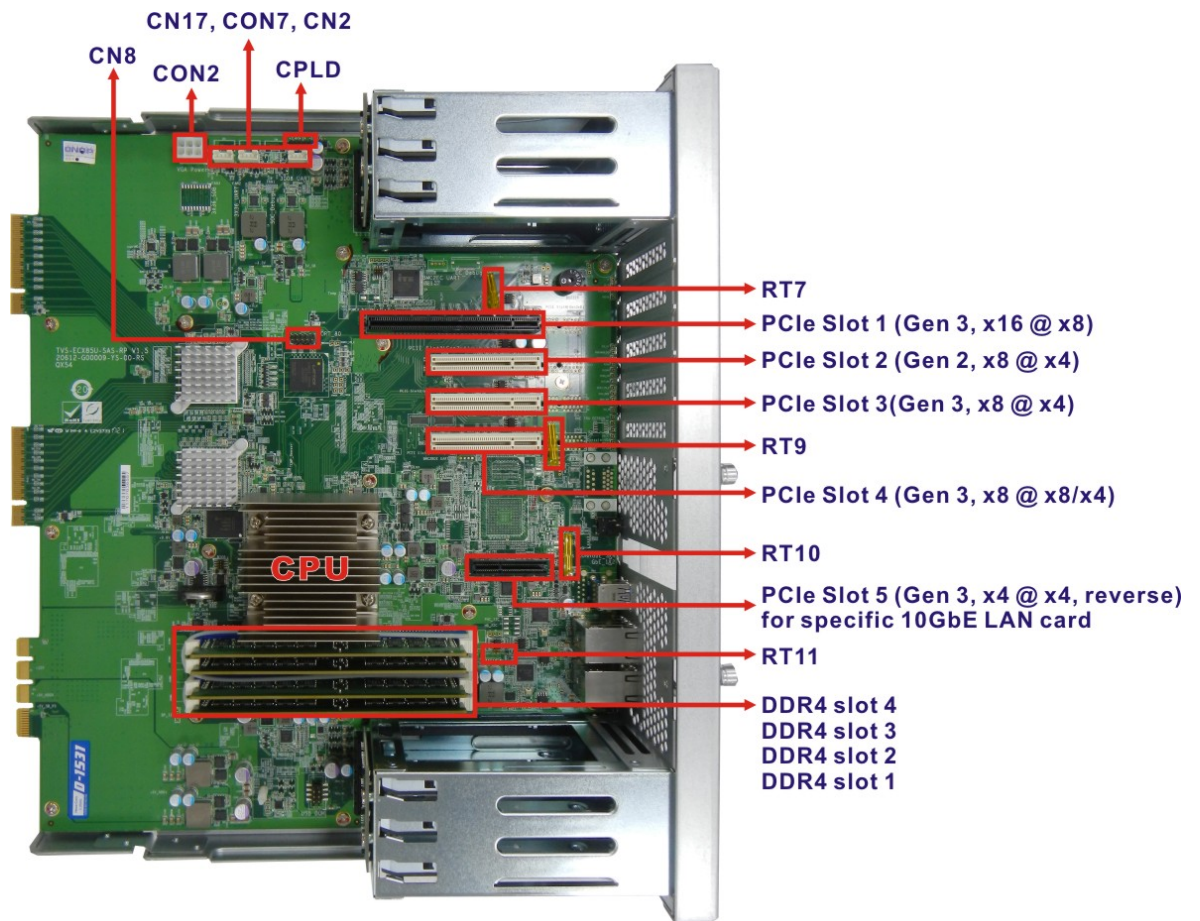

Figure 5-1: Jumper and Connector Locations

5.1.1 CPLD Connector

PIN NO.	DESCRIPTION
1	+3V3_SB
2	CPLD_TDO
3	CPLD_TDI
4	NC
5	NC
6	CPLD_TMS
7	GND
8	CPLD_TCK

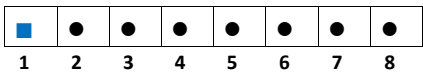

Table 5-1: CPLD Connector Pinouts

5.1.2 10Gbps Host Connector (PCIe Slot 5)

The PCIe Slot 5 (Gen 3, x4 @ x4) is a reverse connector that supports specific 10GbE LAN card (LAN-10G2F-PHY-CS4227).

PIN NO.	DESCRIPTION	PIN NO.	DESCRIPTION
A1	10GBE_SPI_CS	B1	+12V
A2	+12V	B2	+12V
A3	+12V	B3	+12V
A4	GND	B4	GND
A5	LAN_MDC_LED1_1	B5	LAN_MDC_LED0_1
A6	LAN_MDC_LED1_0	B6	LAN_MDC_LED0_0
A7	+3V3_SB	B7	GND
A8	10GBE_SPI_DI	B8	+3.3V
A9	+3.3V	B9	10GBE_SPI_CLK
A10	+3.3V	B10	P1V05
A11	LAN_SDP1_0	B11	10GBE_SPI_DO
A12	GND	B12	SEL_I2C

GRAND-BDE Series

PIN NO.	DESCRIPTION	PIN NO.	DESCRIPTION
A13	LAN_SDP0_0	B13	GND
A14	LAN_SDP0_1	B14	RX1_P
A15	GND	B15	RX1_N
A16	TX1_P	B16	GND
A17	TX1_N	B17	NC
A18	GND	B18	GND
A19	NC	B19	RX0_P
A20	GND	B20	RX0_N
A21	TX0_P	B21	GND
A22	TX0_N	B22	GND
A23	GND	B23	MDIO_DIR_CTL0
A24	GND	B24	MDIO_DIR_CTL1
A25	NC	B25	GND
A26	NC	B26	GND
A27	GND	B27	NC
A28	GND	B28	NC
A29	10G_BaseT	B29	GND
A30	10G_SFP+	B30	LAN_I2C_SCL
A31	GND	B31	LAN_I2C_SDA
A32	NC	B32	GND

Table 5-2: 10Gbps Host Connector (PCIe Slot 5) Pinouts

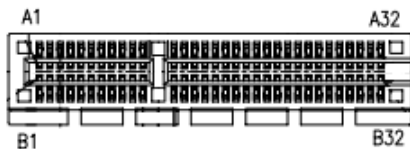

5.1.3 PCIe Power Connector (CON2)

PIN NO.	DESCRIPTION	PIN NO.	DESCRIPTION
1	GND	4	+12V
2	GND	5	+12V
3	GND	6	+12V

The diagram shows a 6-pin PCIe power connector. The pins are arranged in two columns of three. The top row is labeled 6, 1 and the bottom row is labeled 4, 3. The connector has a notch on the left side.

Table 5-3: PCIe Power Connector (CON2) Pinouts

5.1.4 LPC Connector (CN8)

PIN NO.	DESCRIPTION	PIN NO.	DESCRIPTION
1	LPC_CLK	2	LPC_AD1
3	LPC_RST	4	LPC_AD0
5	LPC_FRAME#	6	+3.3V
7	LPC_AD3	8	GND
9	LPC_AD2		



Table 5-4: LPC Connector (CN8) Pinouts

5.1.5 COM Connector (CN2, CN17, CON7)

PIN NO.	DESCRIPTION
1	SOUT
2	+3.3V
3	SIN
4	GND

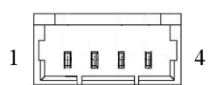

Table 5-5: COM Connector (CN2, CN17, CON7) Pinouts

5.1.6 Thermistor (RT7, RT9, RT10, RT11)

Thermistor operating temperature range: -30°C ~ 100°C



GRAND-BDE Series

5.2 External Interface Panel Connectors

The table below lists the rear panel connectors on the motherboard. Pinouts of these connectors can be found in the following sections.

5.2.1 Ethernet and USB 3.0 Combo Connectors

PIN NO.	DESCRIPTION	PIN NO.	DESCRIPTION	ACT/LINK LED	SPEED LED
1	MDI0+	5	MDI2+		
2	MDI0-	6	MDI2-		
3	MDI1+	7	MDI3+		
4	MDI1-	8	MDI3-		

Table 5-6: Ethernet Connector Pinouts

PIN NO.	DESCRIPTION	PIN NO.	DESCRIPTION
1	+5V	10	+5V
2	USB2P0_DM0	11	USB2P0_DM1
3	USB2P0_DP0	12	USB2P0_DP1
4	GND	13	GND
5	USB3P0_RXDN0	14	USB3P0_RXDN1
6	USB3P0_RXDP0	15	USB3P0_RXDP1
7	GND	16	GND
8	USB3P0_TXDN0	17	USB3P0_TXDN1
9	USB3P0_TXDP0	18	USB3P0_TXDP1

Table 5-7: USB 3.0 Connector Pinouts

5.2.2 Console Port

The console port supports COM signal.

PIN NO.	DESCRIPTION
1	GND
2	SIN1
3	SOUT1
4	NC
5	NC



Table 5-8: Console Port Pinouts

5.2.3 EC GPIO

PIN NO.	DESCRIPTION
1	GND
2	GND
3	L80LLAT/GPE7
4	GND

Table 5-9: EC GPIO Pinouts

5.2.4 SAS Connector

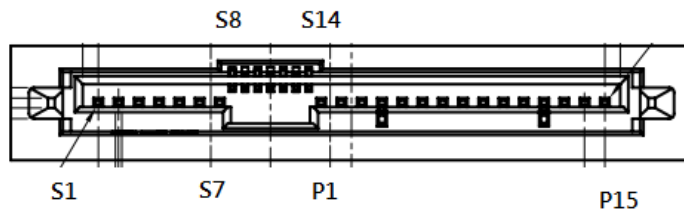

PIN NO.	DESCRIPTION	PIN NO.	DESCRIPTION
S1	GND	P1	NC
S2	BP_SAS_TX_P	P2	NC
S3	BP_SAS_TX_N	P3	BP_HDD1_PWR_EN
S4	GND	P4	GND

GRAND-BDE Series

PIN NO.	DESCRIPTION	PIN NO.	DESCRIPTION
S5	BP_SAS_RX_N	P5	GND
S6	BP_SAS_RX_P	P6	GND
S7	GND	P7	+5V_HDD
S8	GND	P8	+5V_HDD
S9	NC	P9	+5V_HDD
S10	NC	P10	GND
S11	GND	P11	HDD1_LED_ACT#
S12	NC	P12	GND
S13	NC	P13	+12V_PS
S14	GND	P14	+12V_PS
		P15	+12V_PS

Table 5-10: SAS Connector Pinouts

Appendix

A

Regulatory Compliance

DECLARATION OF CONFORMITY

This equipment is in conformity with the following EU directives:

- EMC Directive 2004/108/EC
- Low-Voltage Directive 2006/95/EC
- RoHS II Directive 2011/65/EU

If the user modifies and/or install other devices in the equipment, the CE conformity declaration may no longer apply.

If this equipment has telecommunications functionality, it also complies with the requirements of the R&TTE Directive 1999/5/EC.

English

IEI Integration Corp declares that this equipment is in compliance with the essential requirements and other relevant provisions of Directive 1999/5/EC.

Български [Bulgarian]

IEI Integration Corp. декларира, че този оборудване е в съответствие със съществените изисквания и другите приложими правила на Директива 1999/5/EC.

Česky [Czech]

IEI Integration Corp tímto prohlašuje, že tento zařizení je ve shodě se základními požadavky a dalšími příslušnými ustanoveními směrnice 1999/5/ES.

Dansk [Danish]

IEI Integration Corp erklærer herved, at følgende udstyr overholder de væsentlige krav og øvrige relevante krav i direktiv 1999/5/EF.

Deutsch [German]

IEI Integration Corp, erklärt dieses Gerät entspricht den grundlegenden Anforderungen und den weiteren entsprechenden Vorgaben der Richtlinie 1999/5/EU.

Eesti [Estonian]

IEI Integration Corp deklareerib seadme seadme vastavust direktiivi 1999/5/EÜ põhinõuetele ja nimetatud direktiivist tulenevatele teistele asjakohastele sätetele.

Español [Spanish]

IEI Integration Corp declara que el equipo cumple con los requisitos esenciales y cualesquiera otras disposiciones aplicables o exigibles de la Directiva 1999/5/CE.

Ελληνική [Greek]

IEI Integration Corp ΔΗΛΩΝΕΙ ΟΤΙ ΕΞΟΠΛΙΣΜΟΣ ΣΥΜΜΟΡΦΩΝΕΤΑΙ ΠΡΟΣ ΤΙΣ ΟΥΣΙΩΔΕΙΣ ΑΠΑΙΤΗΣΕΙΣ ΚΑΙ ΤΙΣ ΛΟΙΠΕΣ ΣΧΕΤΙΚΕΣ ΔΙΑΤΑΞΕΙΣ ΤΗΣ ΟΔΗΓΙΑΣ 1999/5/EK.

Français [French]

IEI Integration Corp déclare que l'appareil est conforme aux exigences essentielles et aux autres dispositions pertinentes de la directive 1999/5/CE.

Italiano [Italian]

IEI Integration Corp dichiara che questo apparecchio è conforme ai requisiti essenziali ed alle altre disposizioni pertinenti stabilite dalla direttiva 1999/5/CE.

Latviski [Latvian]

IEI Integration Corp deklarē, ka iekārta atbilst būtiskajām prasībām un citiem ar to saistītajiem noteikumiem Direktīvas 1999/5/EK.

Lietuvių [Lithuanian]

IEI Integration Corp deklaruoja, kad šis įranga atitinka esminius reikalavimus ir kitas 1999/5/EB Direktyvos nuostatas.

Nederlands [Dutch]

IEI Integration Corp dat het toestel toestel in overeenstemming is met de essentiële eisen en de andere relevante bepalingen van richtlijn 1999/5/EG.

Malti [Maltese]

IEI Integration Corp jiddikjara li dan prodott jikkonforma mal-ħtiġijiet essenzjali u ma provvedimenti oħrajn relevanti li hemm fid-Dirrettiva 1999/5/EC.

Magyar [Hungarian]

IEI Integration Corp nyilatkozom, hogy a berendezés megfelel a vonatkozó alapvető követelményeknek és az 1999/5/EC irányelv egyéb előírásainak.

Polski [Polish]

IEI Integration Corp oświadcza, że wyrobu jest zgodny z zasadniczymi wymogami oraz pozostałymi stosownymi postanowieniami Dyrektywy 1999/5/EC.

Português [Portuguese]

IEI Integration Corp declara que este equipamento est□ conforme com os requisitos essenciais e outras disposições da Directiva 1999/5/CE.

GRAND-BDE Series

Româna [Romanian]

IEI Integration Corp declară că acest echipament este în conformitate cu cerințele esențiale și cu celelalte prevederi relevante ale Directivei 1999/5/CE.

Slovensko [Slovenian]

IEI Integration Corp izjavlja, da je ta opreme v skladu z bistvenimi zahtevami in ostalimi relevantnimi določili direktive 1999/5/ES.

Slovensky [Slovak]

IEI Integration Corp týmto vyhlasuje, že zariadenia spĺňa základné požiadavky a všetky príslušné ustanovenia Smernice 1999/5/ES.

Suomi [Finnish]

IEI Integration Corp vakuuttaa täten että IEEteen on direktiivin 1999/5/EY oleellisten vaatimusten ja sitä koskevien direktiivin muiden ehtojen mukainen.

Svenska [Swedish]

IEI Integration Corp förklarar att denna utrustningstyp står i överensstämmelse med de väsentliga egenskapskrav och övriga relevanta bestämmelser som framgår av direktiv 1999/5/EG.

FCC WARNING

This equipment complies with Part 15 of the FCC Rules. Operation is subject to the following two conditions:

- This device may not cause harmful interference, and
- This device must accept any interference received, including interference that may cause undesired operation.

This equipment has been tested and found to comply with the limits for a Class A digital device, pursuant to part 15 of the FCC Rules. These limits are designed to provide reasonable protection against harmful interference when the equipment is operated in a commercial environment. This equipment generates, uses, and can radiate radio frequency energy and, if not installed and used in accordance with the instruction manual, may cause harmful interference to radio communications. Operation of this equipment in a residential area is likely to cause harmful interference in which case the user will be required to correct the interference at his own expense.

Federal Communication Commission Interference Statement

This equipment has been assembled with components that comply with the limits for a Class B digital device, pursuant to Part 15 of the FCC Rules. These limits are designed to provide reasonable protection against harmful interference in a residential installation. This equipment generates, uses and can radiate radio frequency energy and, if not installed and used in accordance with the instructions, may cause harmful interference to radio communications. However, there is no guarantee that interference will not occur in a particular installation. If this equipment does cause harmful interference to radio or television reception, which can be determined by turning the equipment off and on, the user is encouraged to try to correct the interference by one of the following measures:

- Reorient or relocate the receiving antenna.
- Increase the separation between the equipment and receiver.
- Connect the equipment into an outlet on a circuit different from that to which the receiver is connected.
- Consult the dealer or an experienced radio/TV technician for help.

Appendix

B

Safety Precautions

**WARNING:**

The precautions outlined in this chapter should be strictly followed. Failure to follow these precautions may result in permanent damage to the GRAND-BDE.

B.1 Safety Precautions

Please follow the safety precautions outlined in the sections that follow:

B.1.1 General Safety Precautions

Please ensure the following safety precautions are adhered to at all times.

- ***Follow the electrostatic precautions*** outlined below whenever the GRAND-BDE is opened.
- ***Make sure the power is turned off and the power cord is disconnected*** whenever the GRAND-BDE is being installed, moved or modified.
- ***Do not apply voltage levels that exceed the specified voltage range.*** Doing so may cause fire and/or an electrical shock.
- ***Electric shocks can occur*** if the GRAND-BDE chassis is opened when the GRAND-BDE is running.
- ***If considerable amounts of dust, water, or fluids enter the GRAND-BDE,*** turn off the power supply immediately, unplug the power cord, and contact the GRAND-BDE vendor.
- **DO NOT:**
 - Drop the GRAND-BDE against a hard surface.
 - In a site where the ambient temperature exceeds the rated temperature

GRAND-BDE Series

B.1.2 Anti-static Precautions



WARNING:

Failure to take ESD precautions during the installation of the GRAND-BDE may result in permanent damage to the GRAND-BDE and severe injury to the user.

Electrostatic discharge (ESD) can cause serious damage to electronic components, including the GRAND-BDE. Dry climates are especially susceptible to ESD. It is therefore critical that whenever the GRAND-BDE is opened and any of the electrical components are handled, the following anti-static precautions are strictly adhered to.

- ***Wear an anti-static wristband:*** Wearing a simple anti-static wristband can help to prevent ESD from damaging any electrical component.
- ***Self-grounding:*** Before handling any electrical component, touch any grounded conducting material. During the time the electrical component is handled, frequently touch any conducting materials that are connected to the ground.
- ***Use an anti-static pad:*** When configuring or working with an electrical component, place it on an anti-static pad. This reduces the possibility of ESD damage.
- ***Only handle the edges of the electrical component:*** When handling the electrical component, hold the electrical component by its edges.

B.1.3 Product Disposal

**CAUTION:**

Risk of explosion if battery is replaced by and incorrect type. Only certified engineers should replace the on-board battery.

Dispose of used batteries according to instructions and local regulations.

- Outside the European Union - If you wish to dispose of used electrical and electronic products outside the European Union, please contact your local authority so as to comply with the correct disposal method.
- Within the European Union:

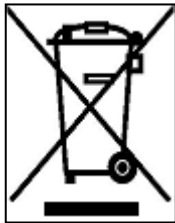

EU-wide legislation, as implemented in each Member State, requires that waste electrical and electronic products carrying the mark (left) must be disposed of separately from normal household waste. This includes monitors and electrical accessories, such as signal cables or power cords. When you need to dispose of your display products, please follow the guidance of your local authority, or ask the shop where you purchased the product. The mark on electrical and electronic products only applies to the current European Union Member States.

Please follow the national guidelines for electrical and electronic product disposal.

B.2 Maintenance and Cleaning Precautions

When maintaining or cleaning the GRAND-BDE, please follow the guidelines below.

B.2.1 Maintenance and Cleaning

Prior to cleaning any part or component of the GRAND-BDE, please read the details below.

GRAND-BDE Series

- The interior of the GRAND-BDE does not require cleaning. Keep fluids away from the GRAND-BDE interior.
- Be cautious of all small removable components when vacuuming the GRAND-BDE.
- Turn the GRAND-BDE off before cleaning the GRAND-BDE.
- Never drop any objects or liquids through the openings of the GRAND-BDE.
- Be cautious of any possible allergic reactions to solvents or chemicals used when cleaning the GRAND-BDE.
- Avoid eating, drinking and smoking within vicinity of the GRAND-BDE.

B.2.2 Cleaning Tools

Some components in the GRAND-BDE may only be cleaned using a product specifically designed for the purpose. In such case, the product will be explicitly mentioned in the cleaning tips. Below is a list of items to use when cleaning the GRAND-BDE.

- **Cloth** – Although paper towels or tissues can be used, a soft, clean piece of cloth is recommended when cleaning the GRAND-BDE.
- **Water or rubbing alcohol** – A cloth moistened with water or rubbing alcohol can be used to clean the GRAND-BDE.
- **Using solvents** – The use of solvents is not recommended when cleaning the GRAND-BDE as they may damage the plastic parts.
- **Vacuum cleaner** – Using a vacuum specifically designed for computers is one of the best methods of cleaning the GRAND-BDE. Dust and dirt can restrict the airflow in the GRAND-BDE and cause its circuitry to corrode.
- **Cotton swabs** - Cotton swaps moistened with rubbing alcohol or water are excellent tools for wiping hard to reach areas.
- **Foam swabs** - Whenever possible, it is best to use lint free swabs such as foam swabs for cleaning.

Appendix

C

Hazardous Materials Disclosure

GRAND-BDE Series

The details provided in this appendix are to ensure that the product is compliant with the Peoples Republic of China (China) RoHS standards. The table below acknowledges the presences of small quantities of certain materials in the product, and is applicable to China RoHS only.

A label will be placed on each product to indicate the estimated “Environmentally Friendly Use Period” (EFUP). This is an estimate of the number of years that these substances would “not leak out or undergo abrupt change.” This product may contain replaceable sub-assemblies/components which have a shorter EFUP such as batteries and lamps. These components will be separately marked.

Please refer to the following table.

Part Name	Toxic or Hazardous Substances and Elements					
	Lead (Pb)	Mercury (Hg)	Cadmium (Cd)	Hexavalent Chromium (CR(VI))	Polybrominated Biphenyls (PBB)	Polybrominated Diphenyl Ethers (PBDE)
Housing	O	O	O	O	O	O
Display	O	O	O	O	O	O
Printed Circuit Board	O	O	O	O	O	O
Metal Fasteners	O	O	O	O	O	O
Cable Assembly	O	O	O	O	O	O
Fan Assembly	O	O	O	O	O	O
Power Supply Assemblies	O	O	O	O	O	O
Battery	O	O	O	O	O	O

O: This toxic or hazardous substance is contained in all of the homogeneous materials for the part is below the limit requirement in SJ/T11363-2006 (now replaced by GB/T 26572-2011).

X: This toxic or hazardous substance is contained in at least one of the homogeneous materials for this part is above the limit requirement in SJ/T11363-2006 (now replaced by GB/T 26572-2011).

此附件旨在确保本产品符合中国 RoHS 标准。以下表格标示此产品中某有毒物质的含量符合中国 RoHS 标准规定的限量要求。

本产品上会附有“环境友好使用期限”的标签，此期限是估算这些物质“不会有泄漏或突变”的年限。本产品可能包含有较短的环境友好使用期限的可替换元件，像是电池或灯管，这些元件将会单独标示出来。

部件名称	有毒有害物质或元素					
	铅 (Pb)	汞 (Hg)	镉 (Cd)	六价铬 (CR(VI))	多溴联苯 (PBB)	多溴二苯 醚 (PBDE)
壳体	○	○	○	○	○	○
显示	○	○	○	○	○	○
印刷电路板	○	○	○	○	○	○
金属螺帽	○	○	○	○	○	○
电缆组装	○	○	○	○	○	○
风扇组装	○	○	○	○	○	○
电力供应组装	○	○	○	○	○	○
电池	○	○	○	○	○	○

○: 表示该有毒有害物质在该部件所有物质材料中的含量均在 SJ/T 11363-2006 (现由 GB/T 26572-2011 取代) 标准规定的限量要求以下。

X: 表示该有毒有害物质至少在该部件的某一均质材料中的含量超出 SJ/T 11363-2006 (现由 GB/T 26572-2011 取代) 标准规定的限量要求。